

53 (2")

3000
(10')
standard
max.

36500
(120')
custom
max.

600
(23.6")

approx 24kg (63lb)

Approved to UL standards by CSA  

Inspired by the sporadic, perhaps discordant arrangement of barnacles on a rock surface, the 21 is fabricated from thin sheets of porcelain wrapped around frosted borosilicate glass trumpet-shaped diffusers. Each diffuser houses a low voltage (12V, 10W halogen/xenon) lamp. A strong contrast is established between the organically distributed soft light passing through the translucent white porcelain skin and the sharp, crisp light passing through the borosilicate glass diffuser.

APPLICATIONS

Suitable for residential and commercial use. CSA and CE approved; approved to UL standards by CSA. Popular applications to date include clusters over tables in residential dining rooms and restaurants, accessory lighting in living rooms, decorative lighting, linear configurations or clusters over bars and kitchen islands, large chandeliers in building lobbies and other public spaces.

MATERIALS

Porcelain, blown borosilicate glass, braided metal coaxial cable, electrical components and a matte white powder coated canopy.

Note: Longest and shortest lengths may have a variance of $\pm 50\text{mm}$ (2")

Note: As an alternative to a built-in transformer, Bocci recommends mounting transformers remotely in an easily accessible and hidden location for ease of long-term maintenance.

Made in Vancouver, Canada

For additional information, please contact:

BOCCI Vancouver
info@bocci.ca
www.bocci.ca

BOCCI Berlin
infoeu@bocci.ca
www.bocci.ca

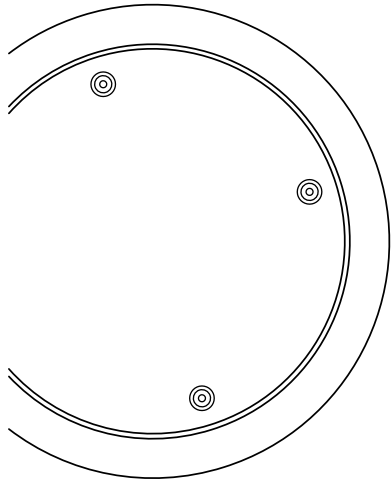

1

Measure and mark out the chandelier canopy position on the ceiling.

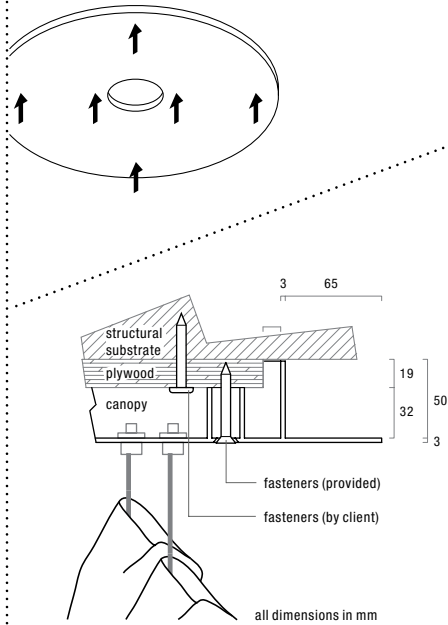

2

Note: The client is responsible for providing a robust 3/4" (19mm) plywood backing or wood blocking to securely anchor to the structural substrate.

Connections from the plywood to the structural substrate are the client's responsibility. Measure the plywood so that it fits within the canopy side walls (refer to detail above).

Anchor the plywood backing to the structural ceiling substrate.

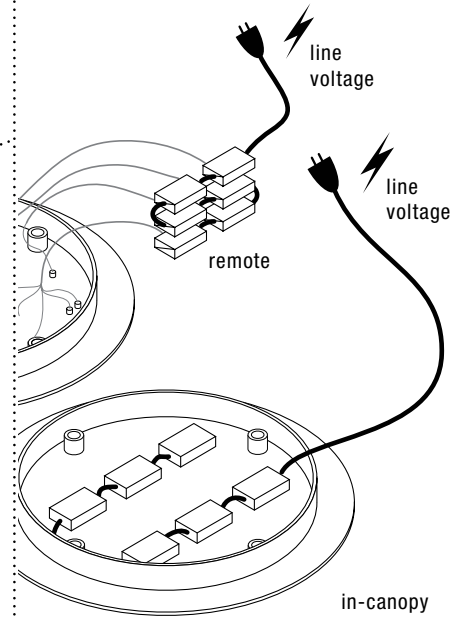

3

Connect transformers inside the canopy to line voltage.

Note: As an option, Bocci recommends mounting transformers remotely in a close by, accessible and hidden location for ease of long term maintenance.

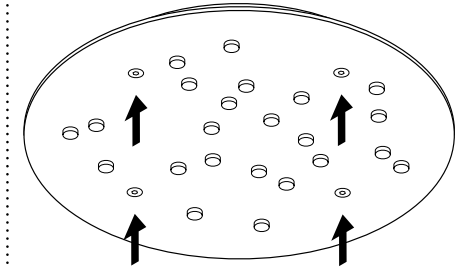

4

Anchor canopy into the plywood backing using the fasteners provided.

If your chandelier has multiple canopies, mount all canopies, one by one, per the previous steps. If your chandelier has only one canopy, proceed to step 5.

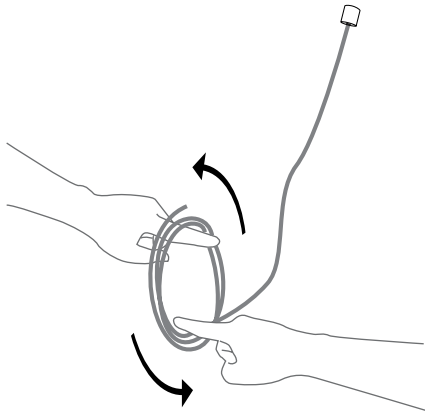

5

Very carefully uncoil the braided coaxial cable in a spool like manner. Insert your index fingers into opposite sides of the roll of coaxial cable then rotate your fingers around each other to unroll the coaxial cable. Use patience: allow the cable to uncoil completely to avoid kinks.

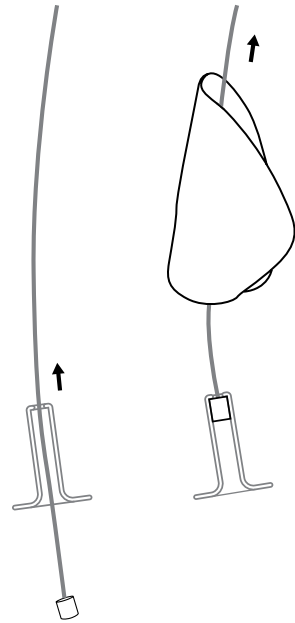

6

Put coaxial cable into the glass trumpet which then threads through the pendant shade.

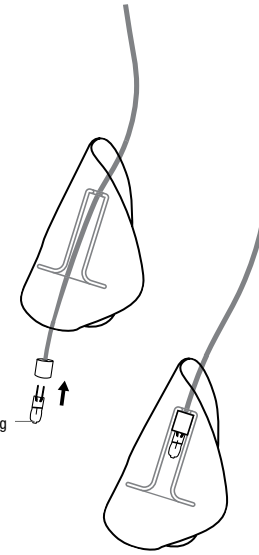

10W Bocci 24.1 long life xenon bipin

7

The 21 pendants are very fragile. Exercise extreme care while handling them.

Each pendant terminates in a "headphone jack" type connector, which plugs into a receiving receptacle in the canopy. Clients are encouraged to compose their own pendant configuration on site, thus creating a truly unique chandelier. After plugging in each pendant, turn the threaded sheathing into place.

Lamp fixture using 24.1 Bocci long life bipin xenon lamps (recommended) or standard bipin halogen lamps.

Plug the lamp to the socket. Do not touch the lamp with your bare hands.

Purchase online for replacement lamps at www.bocci.ca

Note: when using a dimmer, use only low voltage electronic dimmer to ensure the fixture works properly.

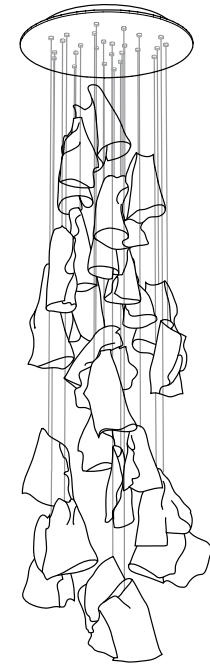

8

Turn fixture on.

*

For additional assistance, please contact Bocci:

BOCCI Vancouver
info@bocci.ca
www.bocci.ca

BOCCI Berlin
infoeu@bocci.ca
www.bocci.ca

Made in Vancouver, Canada

Approved to UL standards by CSA

